



ALL MOUNT

UNIVERSAL UTV PLOW MOUNT KIT

P/N 34-0050

ASSEMBLY / OWNERS MANUAL

Application

PLOW PUSH FRAME NO. 34-0000 or 34-0070

Before you begin, please read these instructions and check to be sure all parts and tools are accounted for. The following instructions contain details required to install and service the contents of this kit.

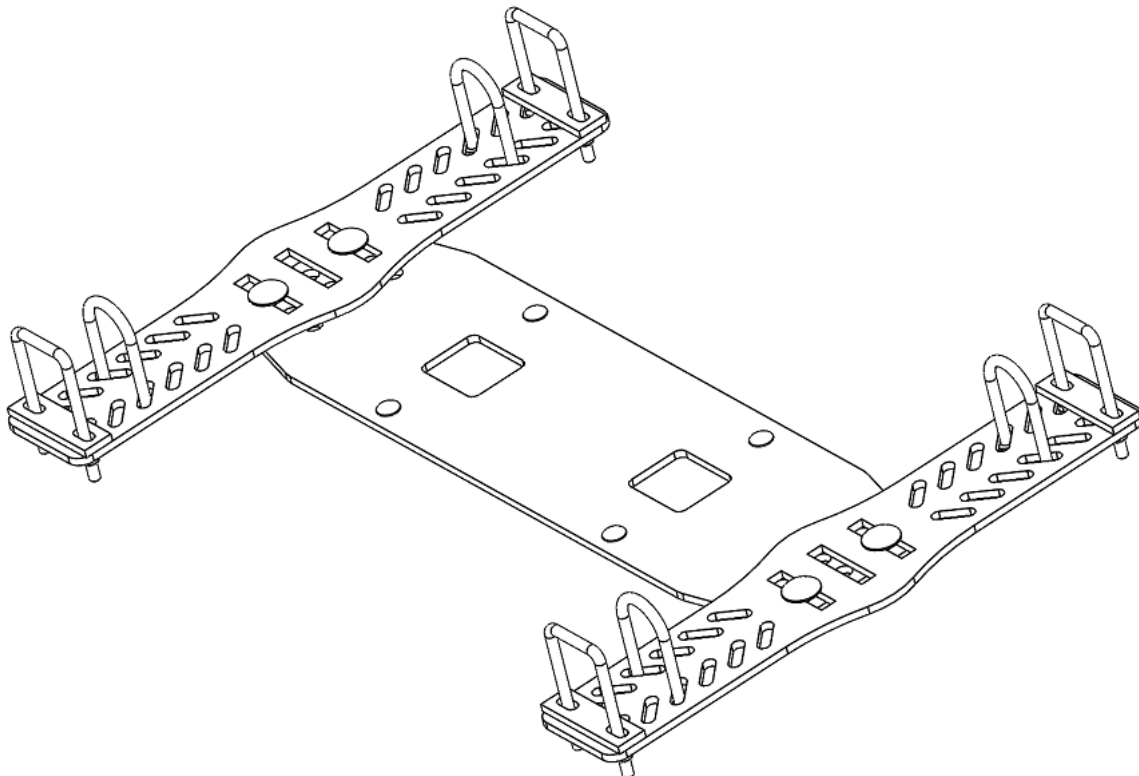

OPERATING INSTRUCTIONS

Congratulations! You've just purchased the most durable plow component in the industry. Kolpin plow components work great for summer or winter plowing. With proper care and maintenance, your Kolpin plow system will last for years to come!

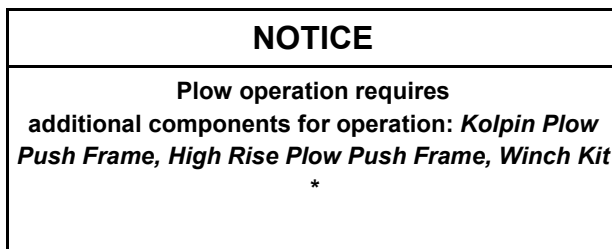



Please read and understand all assembly instructions, notices and warnings before assembling and operating your Kolpin plow system.

Follow these guidelines to ensure satisfactory operation:

- Read this manual and your ATV/ UTV operators manual before use.
- Periodically check for wear and tightness of all fasteners. Replace or re-torque fasteners as necessary.
- Before first use, set plow in the furthest right or left angled position to check for interference with the vehicle.
- Operate with extreme caution on slopes and rough terrain. Be familiar with the area before you plow.
- Be aware of immovable objects that could be hidden in the area you are plowing.
- To avoid damage when pushing snow into a pile, reverse direction before raising the plow blade.
- Do not ram the plow blade into piles of snow.
- For best results, set the suspension preload of your ATV/ UTV to the stiffest setting.
- To reduce steering effort and increase mobility, set the air pressure of your tires to the maximum pressure specification.
- The plow skids are adjustable. General skid setting is even with the plow wear bar bottom edge, higher settings reduce the chance of rocks and gravel from being collected.
- To increase traction during plow operation, operators can try: Securing weight to the ATV/ UTV for additional tire downforce, reducing tire air pressure, or installing tire chains.

SAFETY INFORMATION

Our plow systems were designed with your safety in mind. Please read and understand all Cautions, Notices and Warnings in this manual before you begin. In order to protect you and your ATV/UTV, certain parts of the plow system and/or hardware are designed to fail when the equipment is over-stressed.

 DANGER 
TO AVOID SERIOUS INJURY OR DEATH: <ol style="list-style-type: none">1. DO NOT EXCEED 5 MPH (8 KMH) WITH BLADE INSTALLED.2. OPERATE WITH EXTREME CAUTION ON SLOPES, STEEP GRADES, AND ROUGH TERRAIN.3. ALLOW NO RIDERS ON BLADE OR ATV/UTV WHILE MOVING OR STATIONARY.4. KEEP BYSTANDERS AWAY FROM THE BLADE OR ATV/UTV WHILE MOVING OR STATIONARY.5. WHEN PUSHING HEAVY MATERIAL, DIRECTION CONTROL MAY BECOME DIFFICULT.6. BEFORE ADJUSTING BLADE: STOP ATV/UTV ENGINE; SET AND LOCK BRAKES; RAISE AND LOCK BLADE IN UP POSITION. DO NOT ATTEMPT TO RAISE BLADE BY HAND; USE THE LIFT MECHANISM ONLY.7. LOWER BLADE TO DOWN POSITION WHEN BLADE AND ATV/UTV ARE NOT IN USE.8. READ BLADE'S INSTRUCTION SHEETS AND ATV/UTV OWNER MANUAL.

Kit Contents:

Item	Qty	Part Description	Part Number
1	1	Base Mount Plate	-
2	2	Mount Strap Plate	-
3	4	Spacer Plate	-
4	4	Square U-Bolts	-
5	4	Round U-Bolts	-
6	4	Carriage Bolt, Zinc Plated, M12-1.75 x 40mm LG	-
7	4	Carriage Bolt, Zinc Plated, M8-1.25 x 25mm LG	-
8	16	Flange Locknut, Zinc Plated, M8-1.25	-
9	4	Flange Locknut, Zinc Plated, M12-1.75	-
10	1	Instruction Guide (not shown)	-

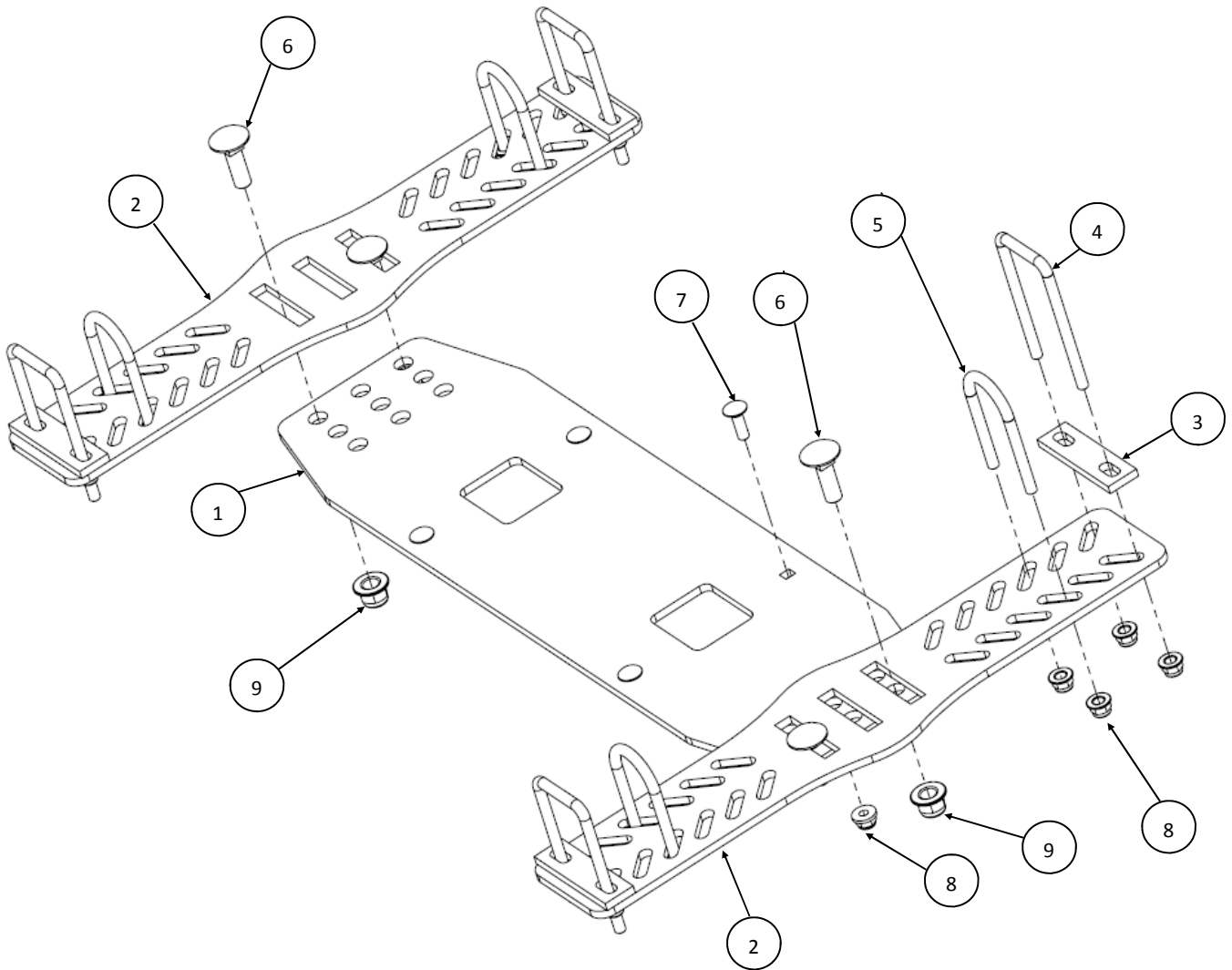

BEFORE YOU BEGIN:

- Your Kolpin accessory is exclusively designed for your vehicle
- Please read and understand all instructions
- Verify all parts and tools are accounted for
- To ensure a satisfactory installation, follow all steps correctly and in the sequence described
- Keep these instructions for future reference or for informational requests
- To facilitate installation, make sure that your vehicle is clean and free of debris
- All directions referring to right and left are when the rider is sitting on the machine
- The plastic skid plate will need to be modified to be reinstalled on the vehicle

TOOLS REQUIRED:

- 13mm Socket
- 19mm Socket
- Drill or cutting tools for plastic
- Depending on vehicle, additional tools may be required to remove plastic skid plate

APPROXIMATE ASSEMBLY TIME: 30 minutes

Note: Removal and modification of the plastic skid plate is recommended.

NOTICE

The ALL MOUNT is designed to attach to multiple UTV brands. Some items contained in the kit are optional and may not be required to complete the installation.

Frequently check to verify the mount is centered under the UTV, does not interfere with other components, and that the approximate mount set-back distance from the front bumper is maintained

NOTICE

Approximate Base Mount Plate, Item #1,

Set-Back Distance: 17-19 inches (43-48 cm)

Measurement Location: Front edge of base mount plate to bottom edge of front bumper

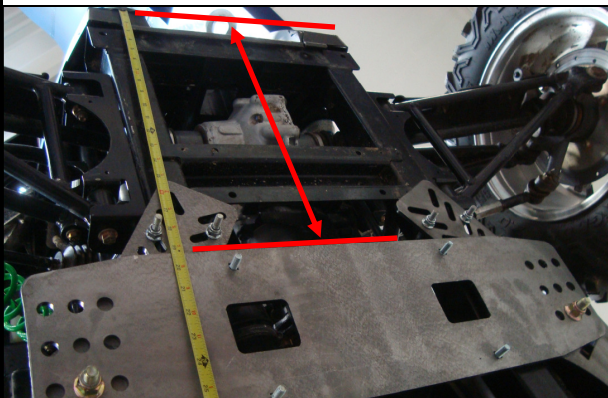

CAUTION

Verify wires, cables, hoses or brake lines are not pinched or damaged during installation.

NOTICE

Install the proper u-bolt for your frame type:

Item #4 = Square Tube Frames

Item #5 = Round Tube Frames

Only four u-bolts are required. U-bolts can be installed to the UTV frame front-to-back, left-to-right or a combination of both.

NOTICE

Plastic skid plate may need to be modified to allow fitment of mount plates.

Plastic skid plate can be re-installed if desired.

Plastic skid plate provides underside protection that mount plates by themselves cannot provide.

Installation Prep:

1. If equipped, detach the plastic skid plate from the vehicle to gain access to vehicle frame mounting locations.

Mount Plate Installation:

1. Pre-determine your u-bolt type and mounting strap locations. Select from provided u-bolts, items #4 or #5 and pre-fit the mount strap plates, item #2, to the frame as shown. (See Illustrations 1-1 and 1-2).
2. **Optional note: For installers who wish to modify and re-install the UTV skid plate, refer to steps 3 and 5, before proceeding to Step 6.**
3. After finding pre-determined u-bolt mounting locations in step 1, trim the skid plate. Mark or scribe locations for u-bolts to fit thru skid plate.
4. Drill holes through the skid plate at locations marked. Use a 3/8" to 1/2" bit to create an oversized hole that will allow some relief when installing hardware. **Note, a high speed cutting tool (like a Dremel) with a cutting bit will also work. (See Illustration 1-3).**
5. Re-install the plastic skid plate(s) using OEM fasteners. (See Illustration 1-3).

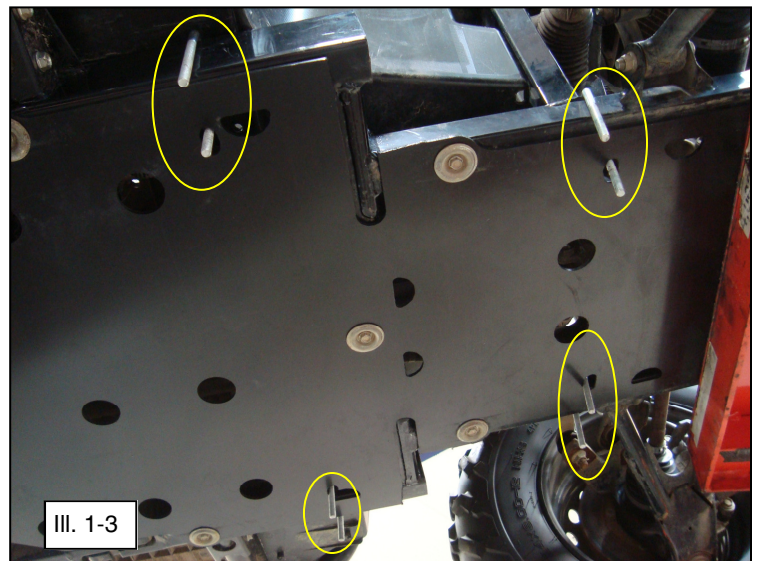
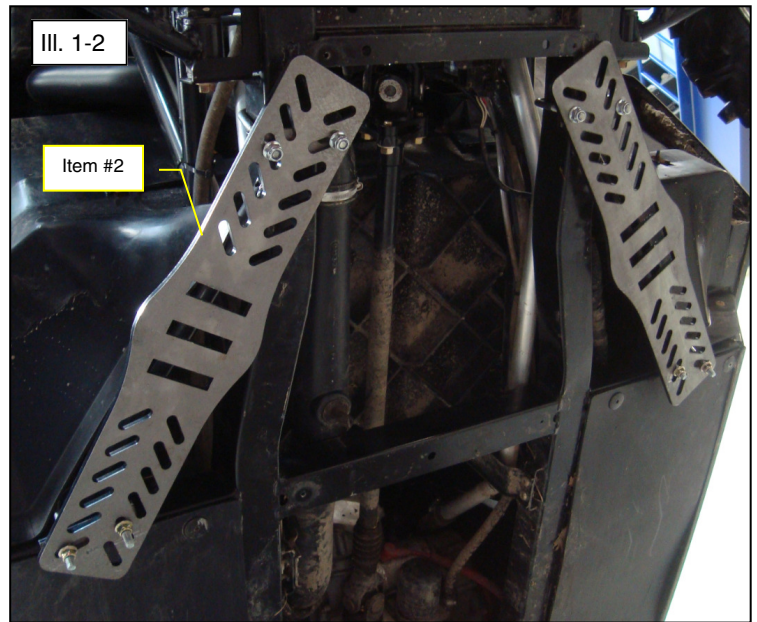
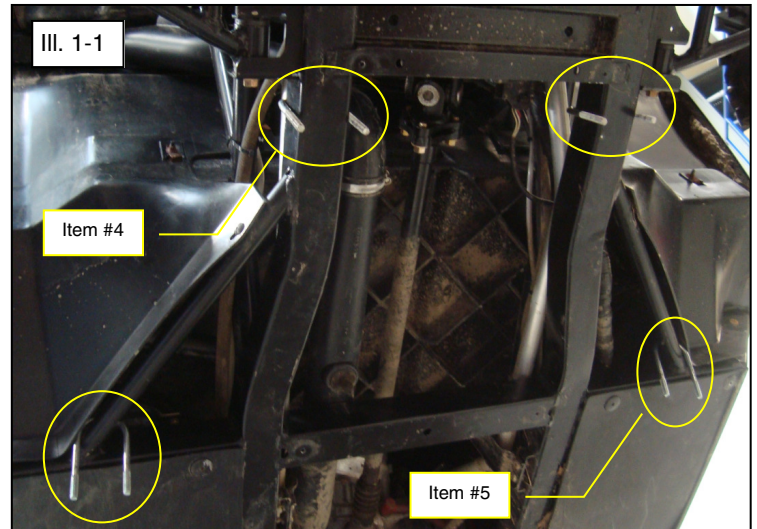

Mount Plate Installation (continued):

6. Insert the u-bolts, items #4 and/or #5, around the pre-determined locations.
7. If required, place spacers, item #3, onto u-bolts to fit between mount strap plates and vehicle frame. Spacers provide options to mount plates evenly to vehicle. (See Illustration 1-4). **Note, spacers are optional and may not be required for certain installations.**
8. Install the mount strap plates using M8 nuts, item #8. Verify the strap plates lay flat and do not contact any part of the vehicle other than the mounting points. Do not tighten fasteners at this time. (See Illustration 1-5).
9. Install the M12 carriage bolts, item #6, into the center slots of the mount strap plates as shown. (See Illustration 1-5). **Note, installing four M12 carriage bolts is preferred, but certain installations may not allow four to be used.**
10. Insert M8 carriage bolts, item #7, into four locations of base plate, item #1. Fasten base mount plate, item #1, to strap plates using M12 lock nuts, item #9, as shown. Do not tighten at this step. (See Illustration 1-6).
11. Verify the base mount plate set-back distance and center within the mount strap plates. Tighten the M12 nuts to specification. (See Illustration 1-7).

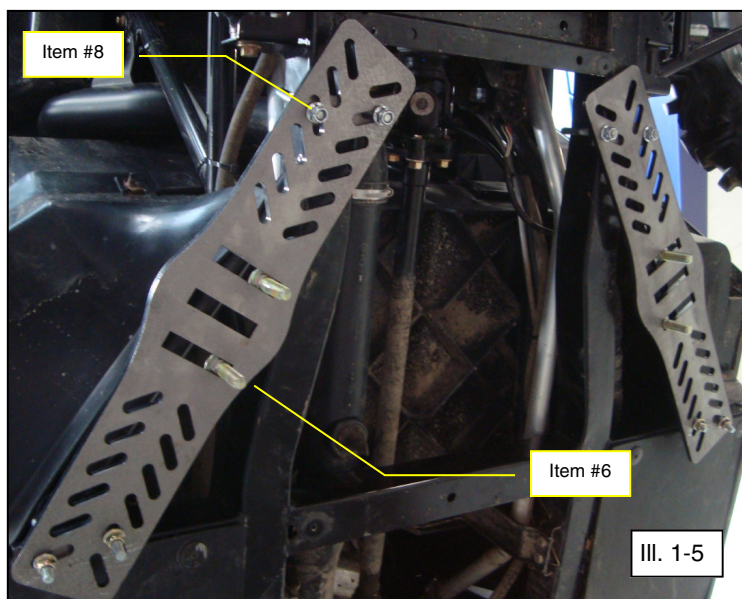
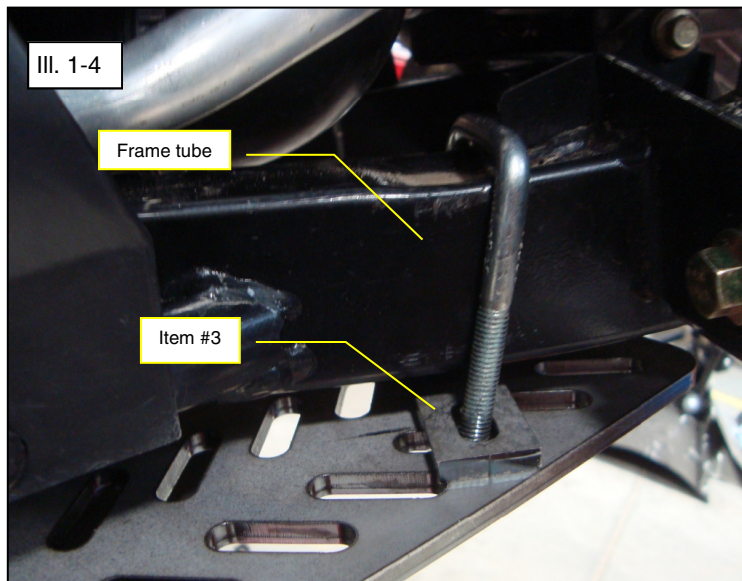

 = T
12MM FASTENER TORQUE:
50 ft. lbs. (67 Nm)

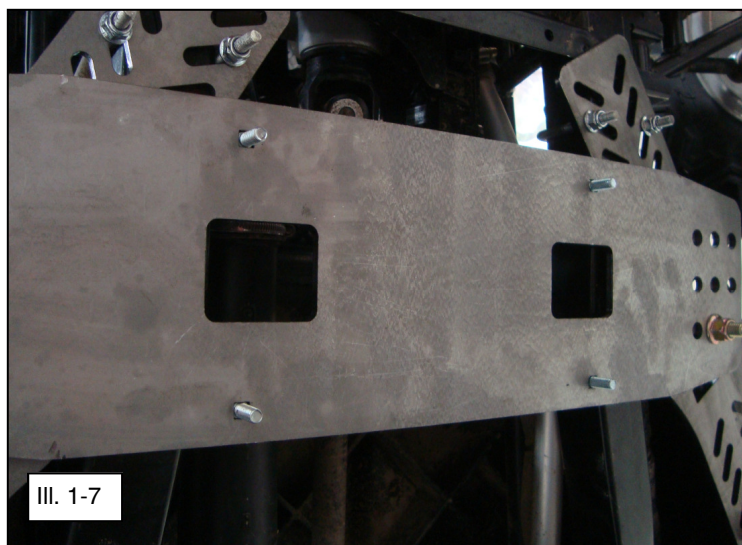
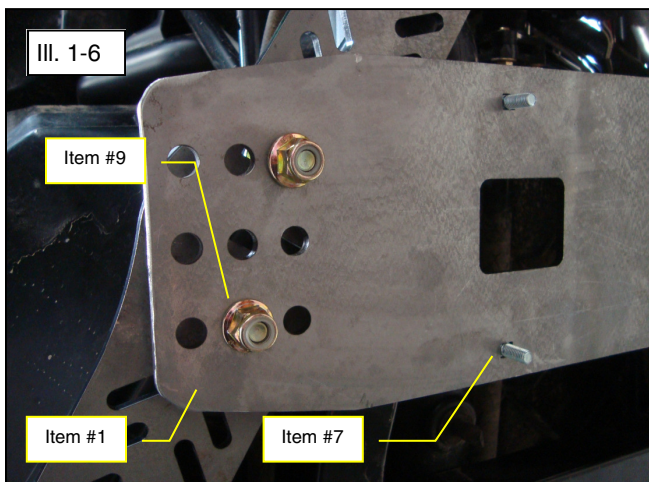

12. Tighten the M8 locknuts for the u-bolts. Do not over-tighten. The excess threads can be trimmed, but leave 3-4 threads exposed past the locknut.

Mount Plate Installation (continued):

13. The universal mount plate, not included in kit, will be attached to the base mount plate as shown. The M8 carriage bolts will fasten universal plate with M8 locknuts, item #8. Tighten to specification. (See Illustration 1-8).

 = T
8MM FASTENER TORQUE: 17 ft. lbs. (23 Nm)

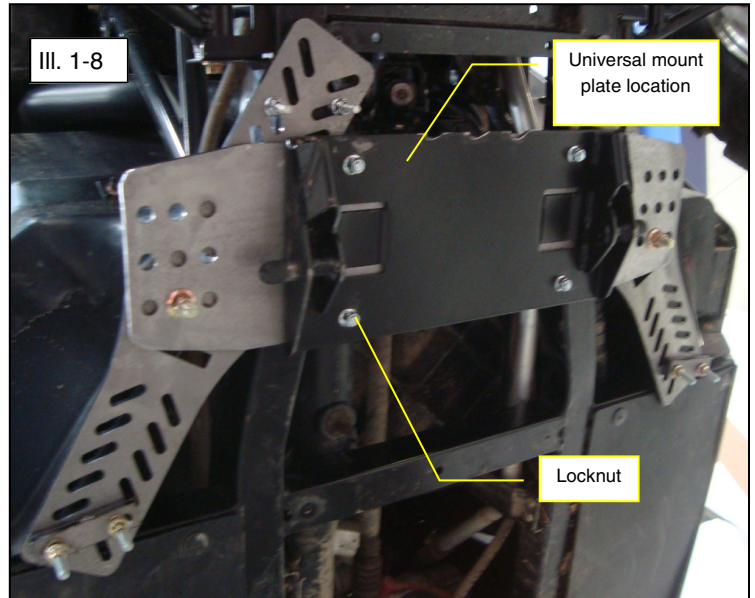

Service Kit

Item	Qty	Part Description	Hardware Service Kit PN 34-0013
1	1	Base Mount Plate	-
2	2	Mount Strap Plate	-
3	4	Spacer Plate	-
4	4	Square U-Bolts	Included
5	4	Round U-Bolts	Included
6	4	Carriage Bolt, Zinc Plated, M12-1.75 x 40mm LG	Included
7	4	Carriage Bolt, Zinc Plated, M8-1.25 x 25mm LG	Included
8	16	Flange Locknut, Zinc Plated, M8-1.25	Included
9	4	Flange Locknut, Zinc Plated, M12-1.75	Included
10	1	Instruction Guide (not shown)	-



One Year Limited Warranty

For the period of one (1) year from the purchase date, Kolpin will replace for the original purchaser, free of charge, any part or parts found upon examination by Kolpin to be defective in material, workmanship, or both.

All transportation costs incurred submitting product to Kolpin for warranty consideration must be borne by the purchaser. If Kolpin determines that the product must be returned to the factory for credit, please call 1-877-956-5746 for a Return Merchandise Authorization (RMA) number and shipping instructions.

This warranty does not apply to parts that have been damaged by accident, alteration, abuse, improper maintenance, normal wear, or other causes beyond the manufacturer's control. In order to protect you and your ATV, certain parts of the plow system and/or hardware are designed to fail when the equipment is over-stressed. Parts that are lost due to loosening and improper maintenance are not covered under warranty. This warranty does not cover removal or reinstallation labor fees of the plow system and related components.

Peripheral products such as engines, electric motors, and actuators may carry an original manufacturer's warranty. Most hardware is general in nature and is easily obtained locally. Be sure to replace with minimum metric class 8.8 specification.

Kolpin Outdoors, Inc.

Telephone: (763)-478-5800

Toll Free: (877)-956-5746

Fax Number: (800)-245-7569

www.kolpin.com

Email: customerservice@kolpin.com